

Field Demonstration of a Real-Time 100-Gb/s PON Based on 10G-Class Optical Devices

Honglin Ji, Lilin Yi, Zhengxuan Li, Lei Xue, Xiang Li, Qi Yang, Suyi Wang, Ying Yang, Shaohua Yu, and Weisheng Hu

Abstract—We have demonstrated the first field trial of a real-time 100-Gb/s passive optical network (PON) with downstream/upstream data rates of 25/10-Gb/s/λ based on 10G-class optical devices supporting 0-40 km differential reach. We employ a single delay-interferometer (DI) to realize chirp management as well as frequency equalization to combat the chromatic dispersion during the fiber transmission and equalize the frequency response of the bandwidth-limited system. Owing to the periodical characteristic, DI can successfully manage the four downstream wavelengths simultaneously. As for the upstream transmission, a fiber Bragg grating (FBG) is employed to compensate the dispersion of the four upstream channels. In addition, an optical amplification deployed at the optical line termination (OLT) is used to amplify the downstream optical power and pre-amplify the upstream signal for supporting more users. All the active and passive components except for transceivers are packaged into a single module in the OLT. The system stability is verified within 67-h real-time bit error rate (BER) measurement. We obtained a power budget of 33 dB with 0-40 km reach of standard single mode fiber (SSMF) based on non-return-to-zero on-off-keying (NRZ-OOK) modulation format for both downstream and upstream.

Index Terms—Chirp management, frequency equalizer, NRZ-OOK, loss budget, dispersion compensation, modulation format, time-division multiplexed passive optical networks.

I. INTRODUCTION

DRIVEN by the increasing user bandwidth demand such as high-quality video and audio, cloud service, high bandwidth 4G and 5G mobile front-haul applications,

Manuscript received August 7, 2016; revised September 29, 2016, and November 8, 2016; accepted November 24, 2016. Date of publication xx xx, 2016; date of current version xx xx, 2016. This work was supported in part by the National Nature Science Foundation of China (61322507, 61132004, and 61575122).

H. Ji, L. Yi, Z. Li, L. Xue, and W. Hu are with the State Key Laboratory of Advanced Optical Communication Systems and Networks, Shanghai Jiao Tong University, Shanghai 200240, China, (e-mail: jhlin90@sjtu.edu.cn; lilinyi@sjtu.edu.cn; antlzx@sjtu.edu.cn; leixue@sjtu.edu.cn; wshu@sjtu.edu.cn).

X. Li, Q. Yi and S. Yu are with the State Key Laboratory of Optical Communication Technologies and Networks, Wuhan Research Institute of Posts & Telecommunications, Wuhan, Hubei 430074, China (e-mail: lixiang@wri.com.cn; qyang@wri.com.cn; shuyu@wri.com.cn).

S. Wang and Y. Yang are with the Fiberhome Telecommunication Technologies Co., Ltd, Wuhan, Hubei 430074, China (e-mail: wangsy@fiberhome.com; yangy906@fiberhome.com).

Copyright©2015 IEEE. Personal use of this material is permitted. However, permission to use this material for any other purposes must be obtained from the IEEE by sending a request to pubs-permissions@ieee.org.

passive optical network (PON) systems with higher capacity are highly desired. The current standardized ITU-T next-generation passive optical network stage 2 (NG-PON2) employs time- and wavelength-division multiplexed PON (TWDM-PON) architecture by stacking four wavelengths, each supporting 10-Gb/s downlink data rate over power-split optical distribution network (ODN), thereby supporting 40-Gb/s downstream capacity [1]. IEEE next-generation Ethernet passive optical network (NG-EPON) has also been discussed in depth to provide a capacity of 100-Gb/s with 25-Gb/s per wavelength, which has attracted extensive attention from the industry [2]. Meanwhile, ITU-T NG-PON2 standardization starts to consider upgrading the capacity from 10-Gb/s to 25-Gb/s per channel. A variety of experimental demonstrations has shown the feasibility of 25-Gb/s capacity per wavelength using the modulation schemes of four-level pulse amplitude modulation (PAM-4) [3-5], electrical duobinary (EDB) [6-7], and optical duobinary (ODB) [8-10], where 10G-class optical devices are highly desired to reduce the system upgradation cost. However, different schemes have their particular advantages and disadvantages. The main advantages of EDB and PAM-4 schemes are the reduced bandwidth requirement for the transceivers, and both are chromatic dispersion (CD) tolerating due to the limited bandwidth. Therefore, we can use relatively low bandwidth optical devices to support high-speed transmission. However, high-speed duobinary-to-binary conversion circuit or digital signal processing (DSP) is required in the optical network unit (ONU) for the demodulation of such advanced modulation schemes. Moreover, PAM-4 requires a linear transceiver, which limits the optical signal extinction ratio and is challenging for the upstream burst-mode (BM) receiver [11]. ODB modulation scheme is beneficial to the fiber transmission as a result of the CD tolerance characteristic. But a high bandwidth Mach-Zehnder modulator (MZM) and high-power electrical drivers are required, which increases the expenditure cost and limits its use within the optical line terminal (OLT). These advanced transmission schemes can also bring about multilevel penalty and degrade the system performance. Most of the previous demonstrations are based on the offline digital signal processing (DSP), thereby requiring more time for practical deployment. And in [12], a real-time 25-Gb/s TDM-PON prototype system with 25-Gb/s downstream based on ODB in C-band is demonstrated, where 25G-class optical devices are used, which are still costly for PON applications. When compared with PAM-4, EDB, and ODB, non-return-to-zero on-off-keying (NRZ-OOK) is a simpler solution with higher sensitivity since only one decision threshold is required. The key advantage of NRZ-OOK is that

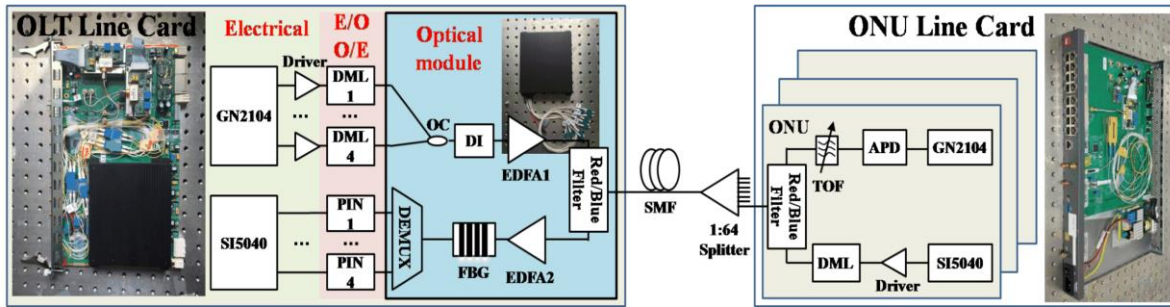

Fig. 1: Transmission scheme of 100G-PON system including the pictures of OLT and ONU line cards

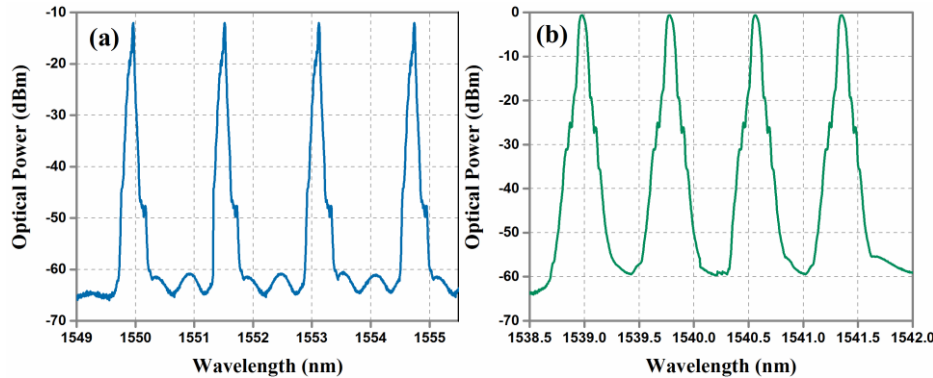

Fig. 2: The measured optical spectra for downstream (a) and upstream (b)

there is no pre-feed forward error correction (FEC) DSP required in ONU, thereby significantly reducing the ONU cost. However, frequency equalization is required for NRZ-OOK as it generally requires higher component bandwidth. Besides, dispersion management is also necessary since NRZ-OOK suffers stronger dispersion penalty than other advanced modulation formats. We have proved that NRZ-OOK can achieve higher loss budget than PAM-4 and EDB under the same components condition by utilizing optical equalization and dispersion management [13].

Except for the modulation format, the choice of the transmitter is also a key factor to achieve low cost and high performance. Currently, most of the experiments based on intensity modulation and direct detection (IM/DD) are using 10G-class electro-absorption modulated laser (EML) as transmitter. EML is considered as a superior laser source owing to its lower frequency chirp. But the optical signal generated by the EML has intensive signal carrier power, which can induce fiber nonlinearities, thereby degrading the system performance. When compared with the EML, directly modulated laser (DML) features higher output power and lower cost. Benefiting from the strong frequency chirp induced spectra broadening of DML, signals generated with DML are more tolerant to high launch power induced fiber nonlinearity, enabling higher loss budget [14]. But the frequency chirp of DML should be well managed to combat the fiber chromatic dispersion, especially in high-speed transmission case above 25-Gb/s where the signal is more likely to be impaired with the pulse broadening induced severe inter-symbol interference (ISI) [15]. By utilizing a single delay-interferometer (DI) to manage the chirp and simultaneously equalize the frequency response, 25-Gb/s NRZ-OOK modulation and transmission has been achieved

based on 10G-class DML [13], which proves that 10G-class DML combined with NRZ-OOK may be a cost-effective candidate solution for 100G-PON.

In our previous report [16], we have first demonstrated a real-time NRZ-OOK based $4 \times 25/10$ -Gb/s TWDM-PON system using off-the-shelf 10G-class DMLs and APD/PINs. To evaluate the whole system performance, long-term stability, and practical feasibility of the above proposals, we designed an OLT line card by integrating all optical and electrical components on a single electrical board. The ONU is integrated into a 1-U frame. Optical equalization based on DI is used for bandwidth improvement and chirp management of cost-effective 10G-class DMLs and APD/PIN receivers. Because of the periodical characteristic, a single DI successfully manages four downlink wavelengths simultaneously. In the OLT, we use two erbium-doped fiber amplifiers (EDFAs) for the downstream and upstream links, respectively. One is utilized to boost the downstream signal optical power before being launched into the fiber to obtain higher-power budget and the other is utilized to pre-amplify the upstream signal to overcome the fiber loss and other devices insertion loss. For the upstream, we use an FBG to compensate the fiber chromatic dispersion. The FBG is also periodical; so, we can employ it to combat the fiber dispersion for all the upstream channels. Electrical clock/data recovery (CDR) chips are integrated on the main board for data generation, recovery, and real-time bit error rate (BER) measurement. The CDR chip can extract the clock from the received electrical signal, which is useful for real-time BER measurement. No pre-FEC DSP is required for the whole system. We evaluated the system performance using 40 km field-installed fiber. The BER keeps below 3.8×10^{-3} for 25.59-Gb/s downstream signal per

wavelength during a 67-h real-time environment measurement with 33 dB loss budget.

Based on our study in [16], we further exploit and analyze the real-time demonstration of 100-Gb/s TWDM-PON system in detail. To verify the effect of DI, we measure the changes in the optical spectrum. Moreover, we look into the characteristic of the system frequency response from the perspective of frequency domain. As for the chromatic dispersion compensation of upstream, we also measure the frequency response to demonstrate the feasibility by using FBG. Then, detailed analysis of the power budget for the downstream link is implemented to get the optimal output power of EDFA before being launched into the fiber. The successful demonstration will facilitate 100G-PON moving forward to practical deployment and applications.

The structure of this paper is as follows: Section II presents the experimental system configuration, the characteristic of the optical module in OLT, and the evaluation of the system performance. In Section III, we present the transmission performance of the real-time 100-Gb/s TWDM-PON system. In this section, we also analyze the optimal power budget and carry out the field-trial demonstration using field-installed fibers. In Section IV, we conclude the results of the experiments.

II. CONFIGURATION OF REAL-TIME OLT AND ONU BOARDS FOR 100G-PON

A. Experimental system

Figure 1 shows the OLT and ONU line cards and the corresponding schematics integrating both the transmitter and receiver modules for the downlink and uplink. The OLT line card consists of three parts: 1) electrical part: 2) electrical-to-optical (E/O) and optical-to-electrical (O/E) conversion part, and 3) optical part. In the electrical part, the CDR chips Semtech GN2104 are used to generate 25.59-Gb/s pseudo-random binary sequence (PRBS) data with a word length of $2^{31}-1$ for the downstream signals and are also used to decode the received signal. The GN2104 chip has four output channels, where the output PRBS data are independent and de-correlated. Note that the CDR chip can be also employed to resample the input PRBS data from an external pulse pattern generator (PPG) or to an external bit error rate tester (BERT) for the reference measurement. The generated downstream link electrical NRZ signal is then amplified by a radio frequency (RF) amplifier with an output amplitude swing of about 1.1 V. The generated NRZ-OOK signal is then loaded onto the 10G-class DML to achieve the E/O conversion with ~ 9 dBm output power. To achieve the downstream 100-Gb/s system capacity, we use four DMLs operating at 1549.96 nm, 1551.52 nm, 1553.12 nm, and 1554.74 nm with 200-GHz channel spacing as transmitters each carrying 25.59-Gb/s NRZ-OOK signal. The optical spectrum of the downstream four wavelengths is shown in Fig. 2(a). The third part in the OLT line card is a key integrated optical module, which includes an optical coupler (OC), one DI, two EDFAs, one FBG, one wavelength de-multiplexer, and one C-band red/blue filter. One of the two EDFAs is utilized for downstream power boosting and another is utilized for upstream optical signal pre-amplification. The picture of the optical module is also

shown in the inset of Fig. 1. Then, the generated four downstream optical signals are launched into the optical module for optical signal processing and power boosting before being launched into the fiber. For the upstream, the received optical signal from different ONUs is also launched into the optical module to compensate for the power attenuation and fiber chromatic dispersion during the uplink transmission. The upstream optical spectrum is also shown in Fig. 2(b). After being processed by the optical module, the upstream optical signal is divided into four parts by a wavelength demux. The four different upstream wavelengths are operating at 1538.98 nm, 1539.77 nm, 1540.56 nm, and 1541.35 nm with 100-GHz channel spacing. So, the upstream system capacity is 40-Gb/s with four wavelengths each carrying 10-Gb/s data. Then, the signal on the four upstream channels are detected by four PINs to achieve O/E conversion. Each PIN is followed by a CDR chip Silicon Labs Si5040. The signal recovery and BER measurement of the 10-Gb/s upstream signal is carried out based on the CDR chip. Similar to the OLT line card, the ONU line card also employs CDR chip GN2104 to measure the BER for 25.59-Gb/s downstream signal, while the chip Si5040 is used to generate 10-Gb/s upstream PRBS data. A tunable optical filter (TOF) is used to select one of the four downstream wavelengths. And the center wavelength of the TOF and the operating wavelength of the DML can be controlled by software to adjust the bias voltage and temperature, respectively. Because of the tunability of TOF and DML, a colorless ONU is achieved. An avalanche photodiode (APD) is employed in ONU to guarantee receiver

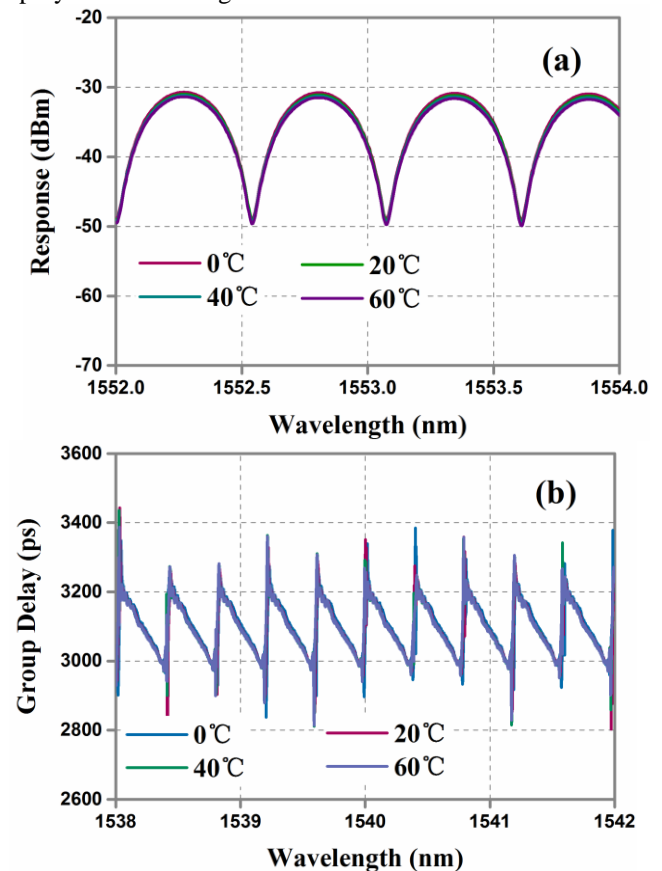

Fig. 3: (a) Spectral response of DI under different temperatures and (b) Group delay profile of FBG under different temperatures

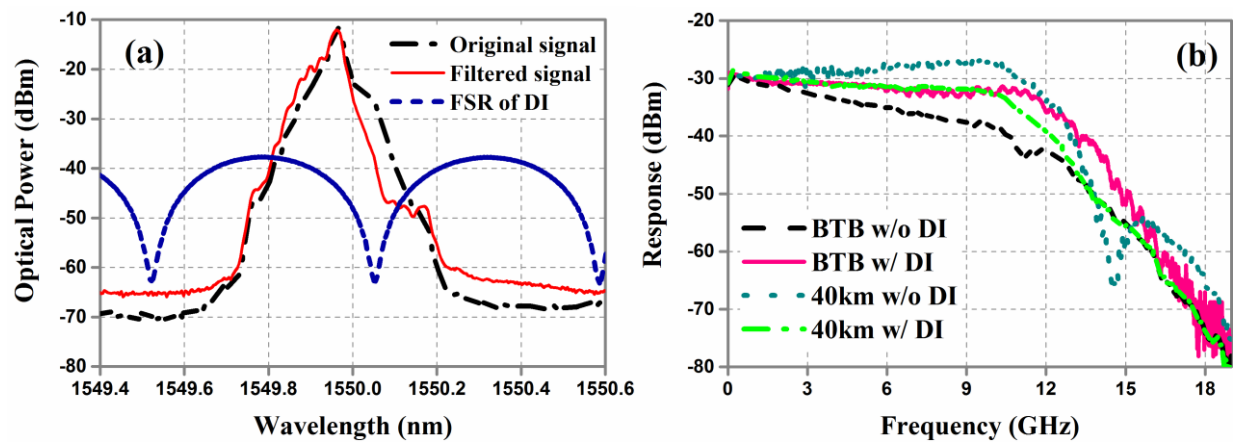

Fig 4: (a) The optical spectra of one downstream wavelength with and without DI and (b) downstream frequency response with and without DI

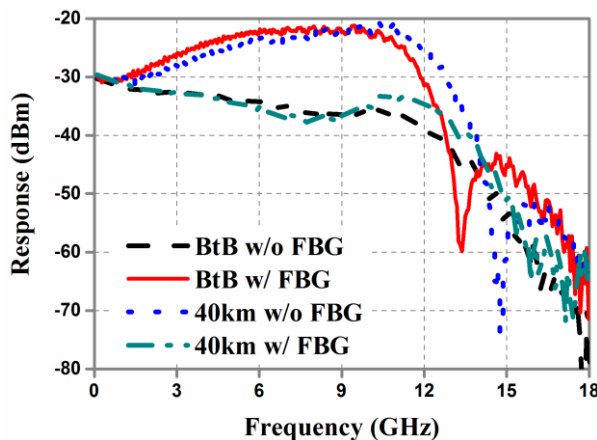

Fig 5: Upstream frequency response with and without FBG

sensitivity. All the DMLs/PINs/APDs in the system are commercialized 10G-class components with 3 dB bandwidth of ~10-GHz, which are the key components to enable the low cost as its cost is proportional to the bandwidth [17].

B. Optical module with two EDFAs

As mentioned earlier, four downstream wavelengths are coupled into a DI using an OC in this module. Owing to the bandwidth-limited and strong frequency chirp characteristics of the DML utilized for the downstream transmitter, a single DI is employed to achieve chirp management and frequency equalization. The DI used in the experiment is commercially available from Optoplex with free spectral range (FSR) of 66.67-GHz and with the periodical characteristic. Therefore, it can support multiple downstream channels with 200-GHz channel spacing. Fig. 3(a) shows the spectral response of the temperature-insensitive DI under different temperatures. It is evident that the passive DI is not sensitive to the temperature. The FSR and the center wavelength of the DI do not drift with the temperature. We then also investigate the temperature characteristic of the FBG. Here, the FBG with -680 ps/nm dispersion value is utilized to compensate the CD of 40 km SMF. The profile of group delay of the temperature-insensitive FBG is shown in Fig. 3(b). The FBG is also not affected by temperature drift. Because of the 50-GHz channel spacing of the FBG group delay profile, the CD compensation for all the upstream channels with 100-GHz channel spacing can be

achieved simultaneously by a single FBG.

C. Evaluation of system performance

The low-cost and low-bandwidth transceivers are one of the major limiting factors to get the achievable performance. Because of the limited bandwidth of the transceivers, some pre-equalization techniques should be used to overcome the defect. So, a single DI is not only utilized as a frequency equalization technique but also for chirp management [13]. The optical spectra of one downstream wavelength optical signal with and without DI-based effects are shown in Fig. 4(a), which are measured by an optical spectrum analyzer (OSA). It can be noted that the optical spectra are obviously broadened after 25.59-Gb/s NRZ-OOK modulation. The chirp management and frequency equalization can be realized by suppressing the low frequency part of the directly modulated signals, which corresponds to the long wavelength part of the optical signal induced by the red-shift chirp. So, the “0”s in the data sequence are suppressed to improve the extinction ratio and make the eye diagram open clearly [18]. The insertion loss of the DI is around 2 dB if the laser wavelength is aligned with the center of the passband. However, due to the detuning effect, the insertion loss of the DI in the system is about 9 dB, which is compensated by the downstream EDFA. To further demonstrate the frequency equalization effect, we also measure the whole system frequency response with and without DI. Fig. 4(b) shows the measured frequency responses of the DML and APD. Owing to the limited bandwidth, the high-frequency response components are very low without DI. But with the DI, we observe that the high-frequency response components are increased due to the frequency equalization effect of the DI. For the upstream, the frequency responses of the 10G-class DML combined with PIN at a wavelength of 1538.98 nm at back-to-back (BtB) and after 40 km fiber transmission with and without FBG are also shown in Fig. 5. We notice that the system bandwidth of 3 dB and 20 dB at BtB case is ~3-GHz and ~14-GHz, respectively. As shown in Fig. 5, it can be observed that the frequency notch at ~15-GHz is induced by the CD of 40 km fiber transmission without the FBG. However, these notches are eliminated when FBG is applied at OLT side to compensate the fiber chromatic dispersion.

III. EXPERIMENTAL RESULT

A. Eye Diagrams for Upstream and Downstream

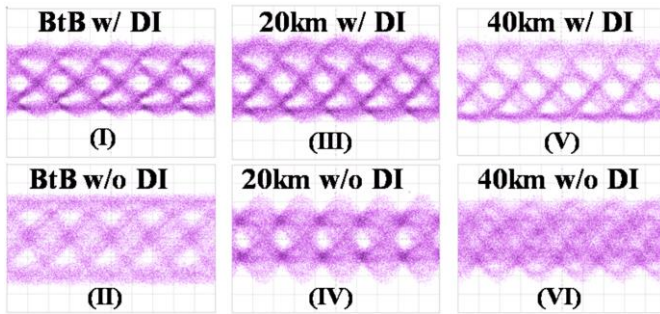

Fig. 6: Insets (I) to (VI) are the eye diagrams of the 25.59-Gb/s downstream signal at back-to-back case and after 20 and 40-km SMF transmission w/ and w/o DI equalization

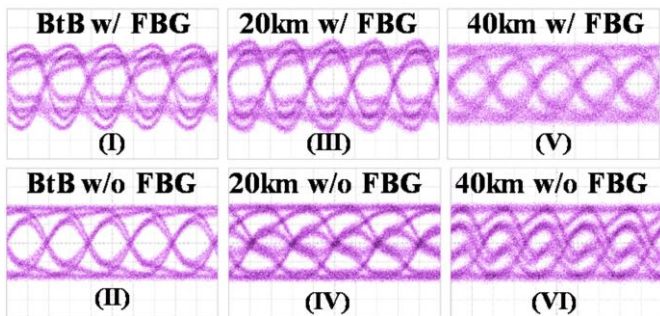

Fig. 7: Insets (I) to (VI) are the eye diagrams of the upstream 10-Gb/s signal at back-to-back case and after 20 and 40 km SMF transmission w/ and w/o FBG compensation

For downstream, we propose to use 10G-class DML and APD to realize 25.59-Gb/s NRZ format combined with DI. The eye diagram at back-to-back (BtB), 20-km, and 40-km fiber transmission with and without DI equalization are shown in Fig. 6. Because of the limited bandwidth of DML and APD, we can see that the 25.59-Gb/s NRZ signal attains duobinary format by the filtering effect of the entire system and the eye diagram is closed. So, a single DI is used to achieve the optical spectra reshaping based on frequency equalization to increase the high-frequency components of the bandwidth-limited signal. Fig. 6(II) and (I) where the eye diagram changes from close to open due to the DI can verify the effect. Because of the strong chirp of DML, we also use DI to achieve chirp management. Fig. 6(III), (IV) and (V), (VI) also demonstrate this. It can be observed that the eye diagram is not impaired by the interaction between frequency chirp and chromatic dispersion. By detuning the wavelength of DMLs using TEC-based temperature tuning, the optimal equalization performance can be achieved.

Then, we also investigate the influence of FBG on the performance of 10-Gb/s upstream signal. The eye diagrams at BtB, 20-km, and 40-km fiber transmission case with and without FBG are shown in Fig. 7. It can be observed that the fiber chromatic dispersion can significantly impair the signal. By employing FBG at the OLT side, we can see that the eye diagram is open clearly. Since the directly modulated signal is tolerant to negative dispersion [19], the FBG with fixed negative dispersion can be used to compensate the CD within the range from 0 to 40-km reach.

B. Optimization of optical launched power

To further exploit the advantage of our system for the downstream, we investigate the dependence of the required optical power for a BER of 1×10^{-3} on the launch power for 40-km SMF link. Therefore, we employ an EDFA to boost the optical power before being launched into the fiber for the four-wavelength or single-wavelength case. The results are presented in Fig. 8. Attributed to the strong frequency chirp induced wide spectrum of DML, the signal generated by the DML is more tolerant to fiber nonlinearity. Therefore, the power launched into the fiber can be more than 14 dBm with only one wavelength existing in the fiber. However, as the four wavelengths coexist in the fiber, the receiver sensitivity of one of the four wavelengths starts to degrade if the power launched into the fiber is more than 18 dBm. Therefore, when four wavelengths coexist in the fiber, the performance is significantly impaired by the high launch power induced fiber nonlinearity. But from the perspective of power budget, we notice that the maximal power budget is 33 dB achieved at the launch power of 19 dBm. When the power launched into the fiber is 19 dBm, the sensitivity is not significantly degraded more than 1 dB when compared with the launch power of 18 dBm. As a result, the power launched into the fiber of 19 dBm is the optimal value for the downstream to get the maximal power budget.

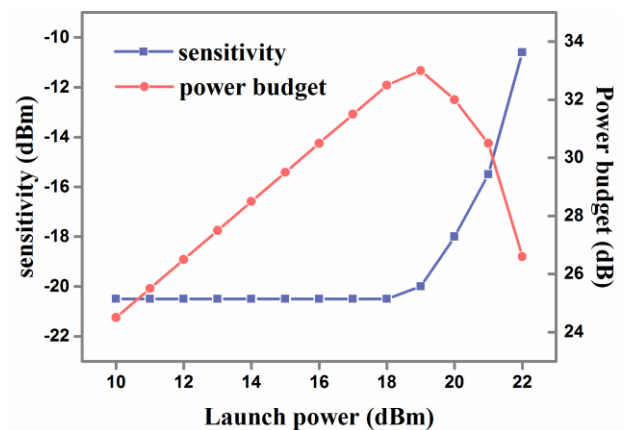

Fig. 8. Required optical power over 40 km SMF for a BER of 10^{-3} versus launch power

C. BER performance

To evaluate the whole TWDM-PON system BER performance, we conduct a lab-environment measurement. We test the BER performance for both the upstream and downstream channels after SMF transmission. For the downstream and upstream, the receivers are followed by a CDR chip to recover the signal clock and count the bit error ratio (BER). So, the measurement is based on the real-time case. For all the below BER measurement, the word length of PRBS data sequence is set at $2^{31}-1$. For the downstream direction, an EDFA is used to boost the optical signal power to obtain higher power budget. The power budget is defined as the power difference between the launch power and the receiver sensitivity (defined at the BER of 1×10^{-3}). As mentioned earlier, the optimal transmitting power for the downstream is 19 dBm. So, the launch power is fixed at 13 dBm per wavelength. Higher launch power will induce fiber

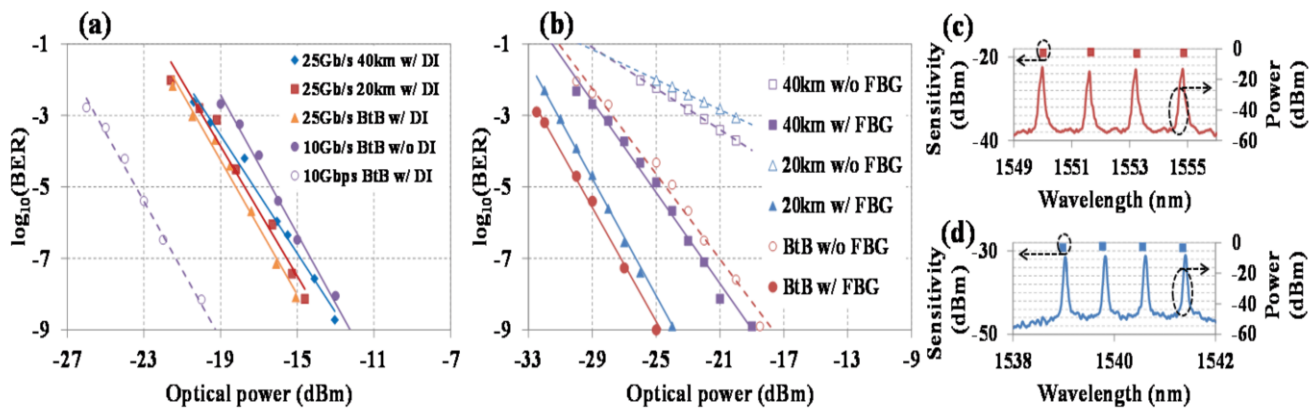

Fig. 9: BER performances versus received optical power for (a) 25.59-Gb/s downstream signal at a wavelength of 1550.1 nm; (b) 10-Gb/s upstream signal at a wavelength of 1539.8 nm. (c) Receiver sensitivity and optical spectra for all the downstream channels; (d) Receiver sensitivity and optical spectra for all the upstream channels

nonlinearities, thereby degrading the system performance. The BER performance subject to different fiber lengths is presented in Fig. 9(a) with and without DI. We first evaluate the 10G-class APD performance using 10-Gb/s NRZ signal. It can be observed that the receiver sensitivity is -18 dBm obtained without DI and -26 dBm obtained with DI due to the higher extinction ratio achieved. To thoroughly analyze the whole system performance, we select the middle wavelength of the four wavelengths. As shown in Fig. 9(a), the receiver sensitivity at the wavelength of 1551.52 nm is \sim -20 dBm after 40-km SMF transmission corresponding to the power budget of 33 dB. Therefore, the system can support 40 km fiber transmission and 64 users with sufficient margin. For the 25.59-Gb/s case without DI, the data cannot be locked by the CDR; therefore, BER cannot be measured. We also examine the dependence of the system performance on the wavelength

for 40-km transmission case. By tuning the center wavelength of the tunable optical filter, the BER versus optical receiver sensitivity are presented for the downstream four wavelengths in Fig. 9(c). The penalty variation at the BER of 1×10^{-3} is within 0.5 dB, indicating that colorless transmission operation in the C-band is feasible with a stable performance. For the 10-Gb/s upstream signal, we use an FBG with -680 ps/nm fix dispersion to compensate the 40-km fiber chromatic dispersion. We also place an EDFA at the OLT side to pre-amplify the optical power. Different transmission cases are shown in Fig. 9(b). Without the FBG, the performance is significantly impaired by the fiber chromatic dispersion. At the 20-km and 40-km transmission cases without FBG, the receiver sensitivity can only reach \sim -22 dBm. It is also observed that the receiver sensitivity is -28 dBm without the FBG at the BtB transmission case. At the BtB with FBG, we can see that the eye diagram is also distorted by negative dispersion in Fig. 7(I). But the performance is better than other transmission cases. With the FBG, the receiver sensitivity after 40-km SMF transmission at the wavelength of 1538.98 nm is as low as -28 dBm. It can be noted that the launch power of the transmitter in the ONU side is 11 dBm. So, the upstream link power budget can achieve 39 dB for 40-km SMF. We also measure the receiver sensitivity of four upstream channels. By detuning the wavelength of the DML using TEC-based temperature tuning, the DML can output any one of the upstream four wavelengths. This is also achieving the colorless operation for the upstream. The receiver sensitivity for the four upstream channels is presented in Fig. 9(d). It can be observed that the receiver sensitivity is basically similar. It is verified that colorless transmission operation for the upstream is also feasible with stable performance.

D. Field-trial demonstration

For the field demonstration, as shown in Fig. 10(a), a round-trip fiber link is chosen between Minhang campus and Qibao campus of Shanghai Jiaotong University (SJTU) with a total fiber length of 40 km. Both the OLT and ONU boards are located at Minhang campus. The BER performance of the downstream channel #2 operating at 1551.52 nm after \sim 67-h (240578 s) real-time measurement is shown in Fig. 10(b). The variation of BER along the 67-h is small, and the average value of BER is 7.5×10^{-4} , well below the 7% threshold of 3.8×10^{-3} . It

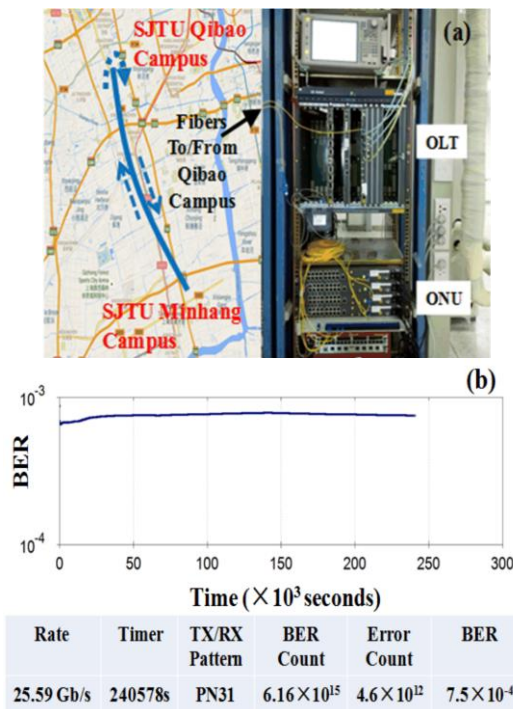

Fig. 10: (a) Map of the round-trip link in SJTU and photo of the 100-Gb/s TWDM-PON systems; (b) BER performance of the downstream signal during 67-h real-time measurement

can be noted that the total loss of the system in the field demonstration is 18 dB due to the degraded field-installed fiber loss. The overall launch power of the four downstream channels is 19 dBm and the achieved BER performance is better than the lab environment. We assume that this difference comes from the higher loss of the field-installed fiber bringing about better nonlinearity-tolerance. Since the power budget is 33 dB in the downlink, the number of users is set to 16 in the field transmission system. Benefiting from the system stability and the temperature insensitivity of DI and FBG, our demonstrated 100G-PON system can be a stable operation with field-installed fiber in the long term.

IV. CONCLUSION

To our knowledge, we have demonstrated the first field trial of a real-time 100-Gb/s TWDM-PON system with 4×25 -Gb/s downstream and 4×10 -Gb/s upstream transmission using 10G-class DMLs and APD/PIN receivers with a power budget of 33 dB after 40-km SMF transmission. A single DI is employed to achieve frequency equalization and chirp management simultaneously for the bandwidth-limited DMLs. It is also noted that the transmission scheme is based on the NRZ-OOK format for 25-Gb/s data rate using 10G-class optical devices. The system performance is also evaluated using deployed 40-km fiber infrastructure over 67-h real-time BER measurement with stable performance.

REFERENCES

[1] ITU-T G.989.1, "40-Gigabit-capable passive optical networks (NG-PON2): General requirements," 2013.

[2] IEEE 802.3 Ethernet Working Group, "Industry connections feasibility assessment for the next generation of EPON," 2015.

[3] H. Zhang, S. Fu, J. Man, W. Chen, X. Song, and L. Zeng, "30km downstream transmission using 4×25 Gbps 4-PAM modulation with commercial 10 Gbps TOSA and ROSA for 100 Gb/s-PON," Presented at the Optical Fiber Communication Conf. Exhibition, San Francisco, CA, USA, 2014, Paper M2I.3.

[4] V. Houtsma and D. V. Veen, "Demonstration of symmetrical 25-Gbps TDM-PON with 31.5 dB optical power budget using only 10-Gbps optical components," Presented at the European Conf. Exhibition Optical Communication, Valencia, Spain, Sep. 2015, Paper PDP. 4.3.

[5] J. Wei, N. Eiselt, H. Griesser, K. Grobe, M. Eiselt, J. J. Vegas-Olmos, I. T. Monroy, and J.-P. Elbers, "First demonstration of real-time end-to-end 40 Gb/s PAM-4 system using 10-G transmitter for next generation access applications," Presented at the European Conf. Exhibition Optical Communication, Valencia, Spain, Sep. 2015, Paper PDP 4.4.

[6] Z. Li, L. Yi, X. Wang, and W. Hu, "28 Gb/s duobinary signal transmission over 40 km based on 10 GHz DML and PIN for 100 Gb/s PON," *Opt. Exp.*, vol. 23, no. 16, pp. 20249–20256, Aug. 2015.

[7] V. Houtsma, D. van Veen, A. Gnauck, and P. Iannone, "APD-based duobinary direct detection receivers for 40 Gbps TDM-PON," Presented at the Optical Fiber Communication Conf. Exhibition, Los Angeles, CA, USA, 2015, Paper Th4H.1.

[8] Z. Ye, S. Li, N. Cheng, and X. Liu, "Demonstration of high-performance cost-effective 100-Gb/s TWDM-PON using 4×25 -Gb/s optical duobinary channels with 16-GHz APD and receiver-side post-equalization," Presented at the European Conf. Exhibition Optical Communication, Valencia, Spain, Sep. 2015, Paper Mo.3.4.4.

[9] D. van Veen, V. Houtsma, A. Gnauck, and P. Iannone, "Demonstration of 40-Gb/s TDM-PON over 42-km with 31 dB optical power budget using an APD-based receiver," *J. Lightw. Technol.*, vol. 33, no. 8, pp. 1675–1680, Apr. 15, 2015.

[10] A. Gnauck, P. Iannone, D. van Veen, and V. Houtsma, " 4×40 -Gb/s/TWDM PON downstream transmission over 42 km and 64-way power split using optical duobinary signals and an APD-based receiver," *Opt. Exp.*, vol. 23, no. 19, pp. 24133–24139, Sep. 2015.

[11] D. van Veen and V. Houtsma, "High speed TDM-PON beyond 10G" Presented at the Optical Fiber Communication Conf. Exhibition, California, CA, USA, 2016, Paper Tu3C.3.

[12] S. Li, Z. Ye, N. Cheng, and X. Liu, "Demonstration of a real-time 25-Gb/s TDM-PON system with 25-Gb/s downstream based on optical duobinary and 10-Gb/s burst-mode upstream based on NRZ," Presented at the Optical Fiber Communication Conf. Exhibition, California, CA, USA, 2016, Paper Th1I.3.

[13] Z. Li, L. Yi, H. Ji, and W. Hu, "100-Gb/s TWDM-PON based on 10G optical devices," *Opt. Exp.*, vol. 24, no. 12, pp. 12941–12948, 2016.

[14] Z. Li, L. Yi, W. Wei, M. Bi, H. He, S. Xiao, and W. Hu, "Symmetric 40-Gb/s, 100-km passive reach TWDM-PON with 53 dB loss budget," *J. Lightw. Technol.*, Technol. 32(21), pp. 3991–3998, 2014.

[15] J. Gao, "Demonstration of the first 29dB power budget of 25-Gb/s/4-PAM system without optical amplifier for next generation access network," Presented at the Optical Fiber Communication Conf. Exhibition, California, CA, USA, 2016, Paper Th1I.2.

[16] L. Yi, H. Ji, Z. Li, X. Li, C. Li, Q. Yang, L. Xue, X. Wang, S. Wang, Y. Yang, J. Xu, S. Yu, and W. Hu, "Field-trial of a real-time 100 Gb/s TWDM-PON based on 10G-class optical devices," Presented at the European Conf. Exhibition Optical Communication, Düsseldorf, Germany, Sep. 2016, Paper W3.E. 1.

[17] J. L. Wei, K. Grobe, C. Sánchez, E. Giacomidis, and H. Griesser, "Comparison of cost- and energy-efficient signal modulations for next generation passive optical networks," *Opt. Exp.*, vol. 23, no. 22, pp. 28271–28281, Nov 2015.

[18] Z. Zhou, M. Bi, S. Xiao, Y. Zhang, and W. Hu, "Experimental demonstration of symmetric 100-Gb/s DML-based TWDM PON system," *IEEE Photon. Technol. Lett.*, vol. 27, no. 5, pp. 470–473, Mar 2015.

[19] L. Yi, X. Wang, Z. Li, J. Huang, J. Han, and W. Hu, "Upstream dispersion management supporting 100 km differential reach in TWDM-PON," *Opt. Exp.*, vol. 23, no. 6, p. 7971, 2015.